

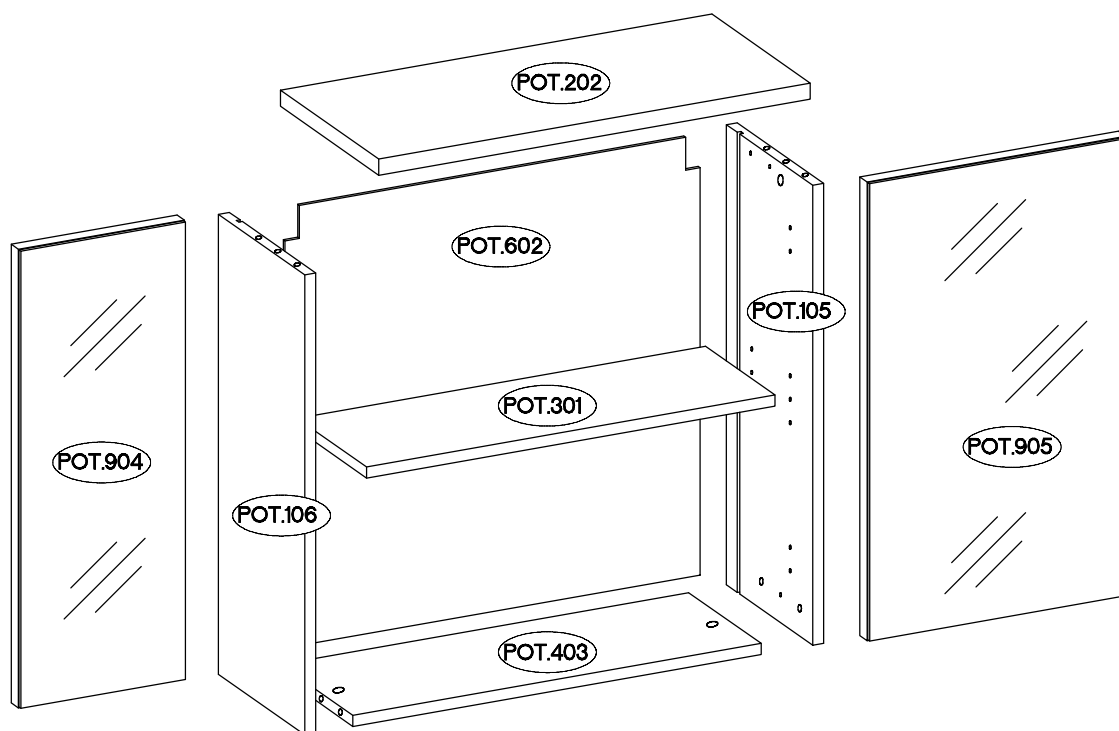

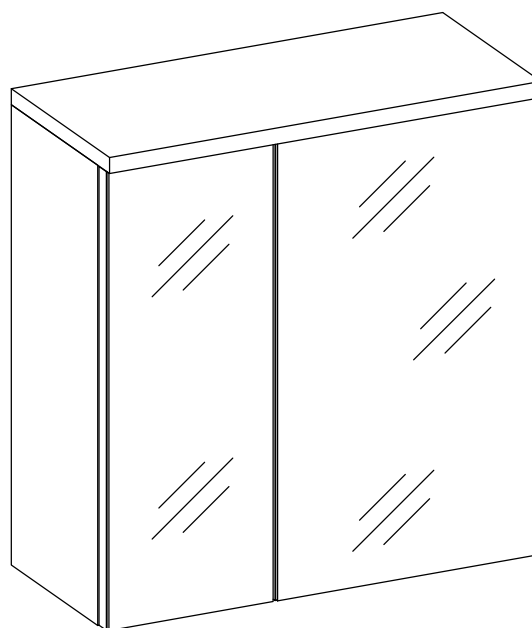













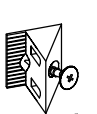

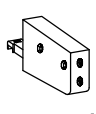

PORTO 402

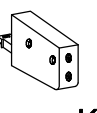

						 †7/2mm J5 2	 †5/16mm J3 4	 †3.0x20mm P7 4	 E 4
 L=20mm D2 4	 †15/12mm C 4	 †8x30mm A 8	 L 5	 O1 1	 K 2	 †4.0x30mm P8 4	 H=0 H 4	 †35/0mm G 4	 †3.5x13mm P5 8

1

L=20mm  D2 4	±15/12mm  C 4	±8x30mm  A 8	 K 2	±4.0x30mm  P8 4	 O1 1
---	--	---	--	--	---

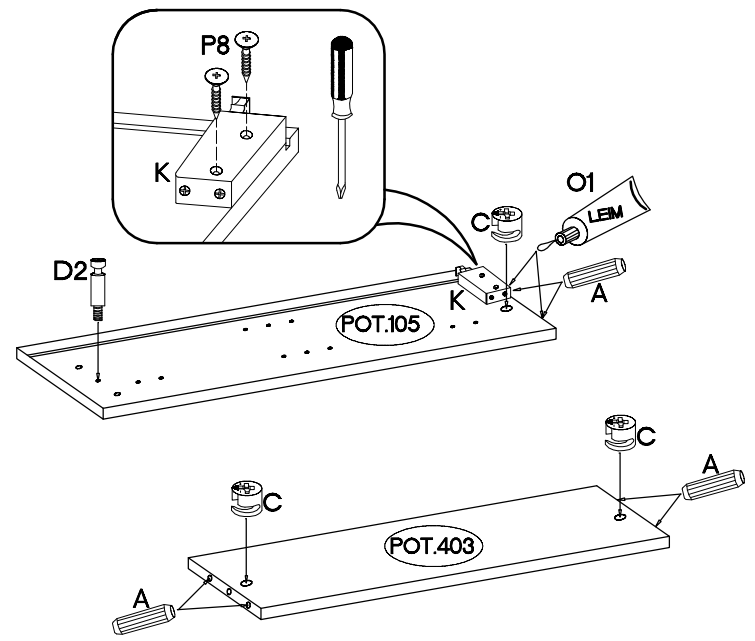
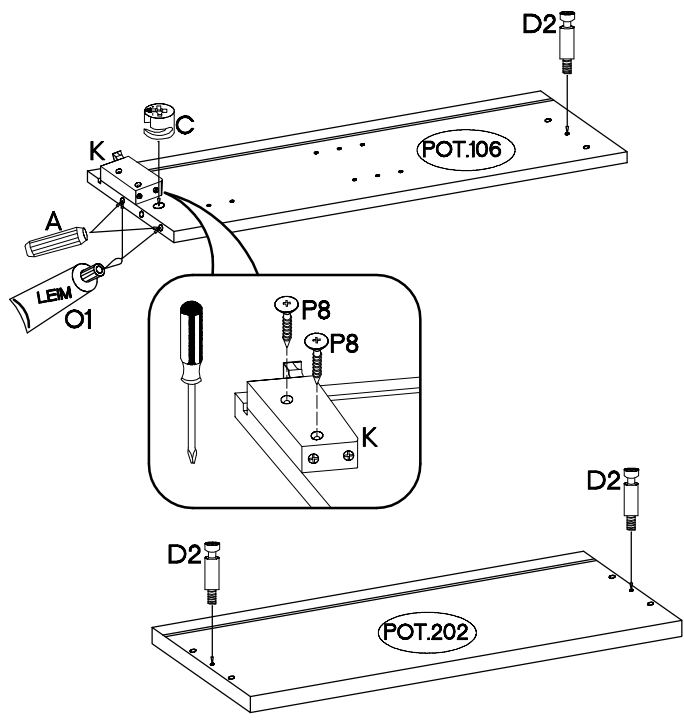
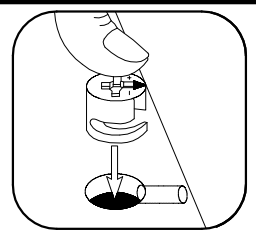
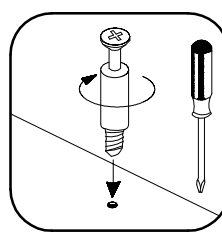

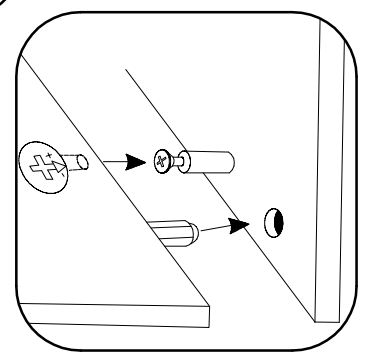
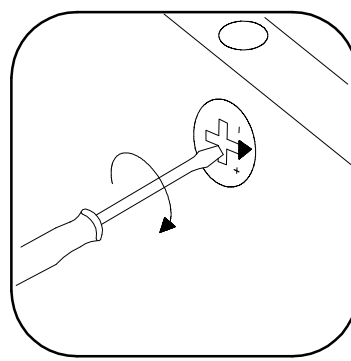
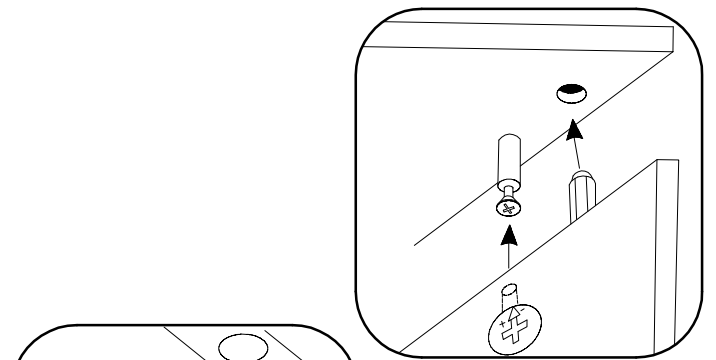
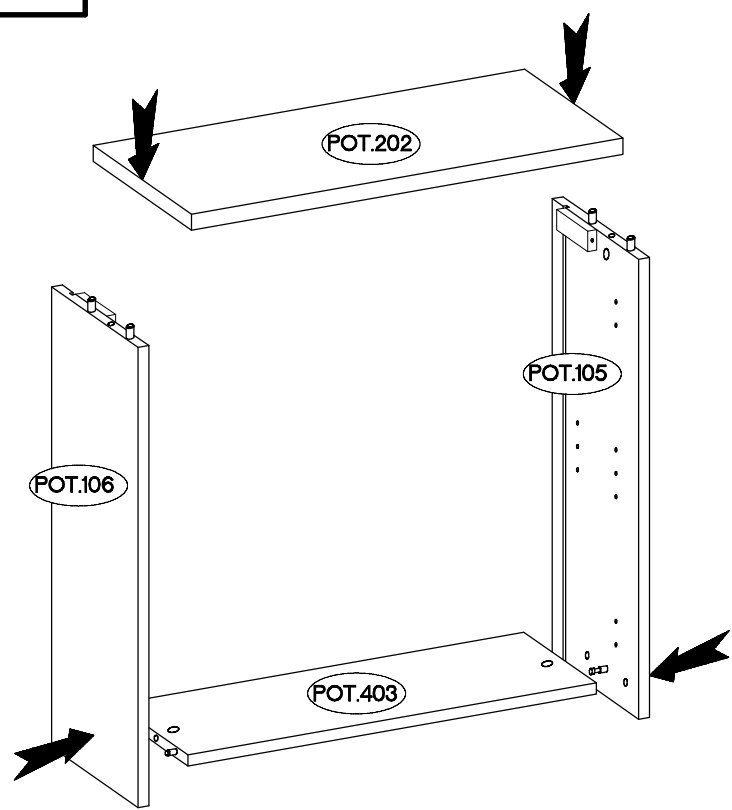

2

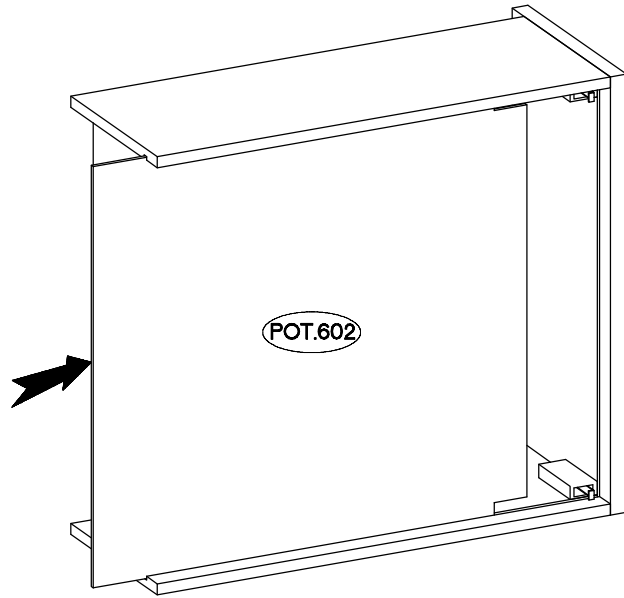

3



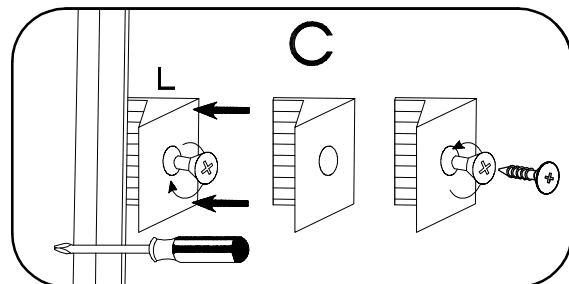
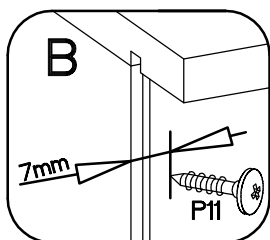
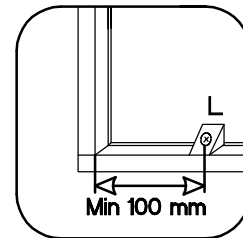
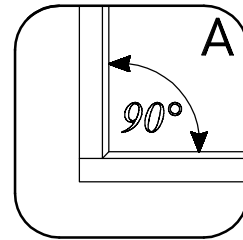
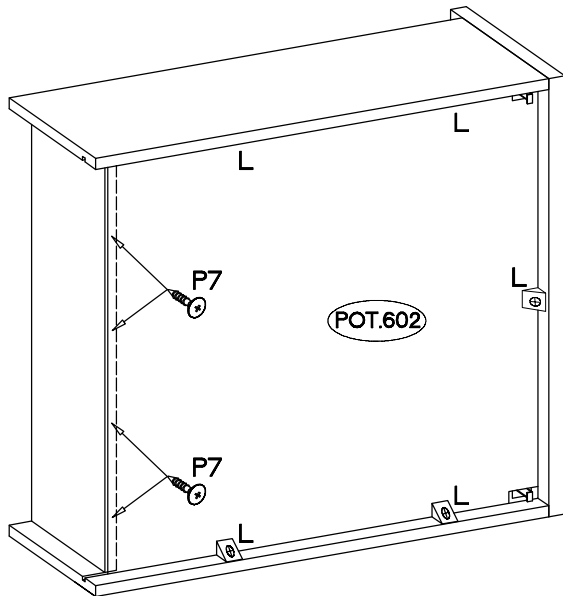

4

	$\pm 3.0 \times 20 \text{ mm}$
5	
	4



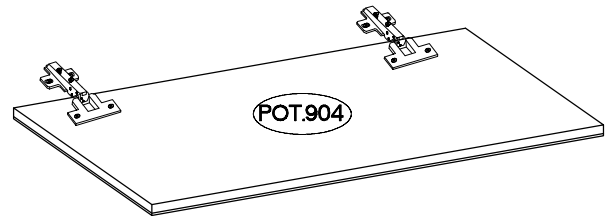
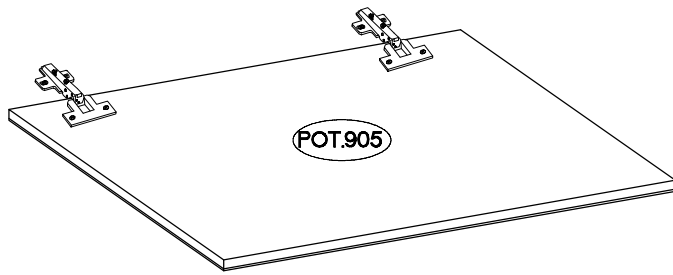
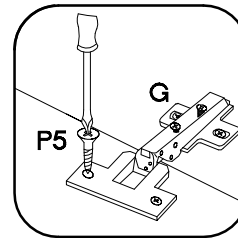
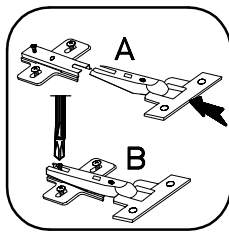

5

H=0  H	+35/0mm  G	+3.5x13mm  P5
4	4	8



6

+5/16mm  J3	 E
4	4
+7/2mm  J5	
2	

